

SIEMENS

SIMATIC

SIMATIC IOT SIMATIC IOT2020, SIMATIC IOT2040

Operating Instructions

Preface

Overview

1

Safety instructions

2

Installing and connecting the device

3

Software and commissioning

4

Expand device

5

Maintaining and repairing the device

6

Technical specifications

7

Technical support

A

List of abbreviations

B

Legal information

Warning notice system

This manual contains notices you have to observe in order to ensure your personal safety, as well as to prevent damage to property. The notices referring to your personal safety are highlighted in the manual by a safety alert symbol, notices referring only to property damage have no safety alert symbol. These notices shown below are graded according to the degree of danger.

⚠ DANGER
indicates that death or severe personal injury will result if proper precautions are not taken.
⚠ WARNING
indicates that death or severe personal injury may result if proper precautions are not taken.
⚠ CAUTION
indicates that minor personal injury can result if proper precautions are not taken.
NOTICE
indicates that property damage can result if proper precautions are not taken.

If more than one degree of danger is present, the warning notice representing the highest degree of danger will be used. A notice warning of injury to persons with a safety alert symbol may also include a warning relating to property damage.

Qualified Personnel

The product/system described in this documentation may be operated only by **personnel qualified** for the specific task in accordance with the relevant documentation, in particular its warning notices and safety instructions. Qualified personnel are those who, based on their training and experience, are capable of identifying risks and avoiding potential hazards when working with these products/systems.

Proper use of Siemens products

Note the following:

⚠ WARNING
Siemens products may only be used for the applications described in the catalog and in the relevant technical documentation. If products and components from other manufacturers are used, these must be recommended or approved by Siemens. Proper transport, storage, installation, assembly, commissioning, operation and maintenance are required to ensure that the products operate safely and without any problems. The permissible ambient conditions must be complied with. The information in the relevant documentation must be observed.

Trademarks

All names identified by ® are registered trademarks of Siemens AG. The remaining trademarks in this publication may be trademarks whose use by third parties for their own purposes could violate the rights of the owner.

Disclaimer of Liability

We have reviewed the contents of this publication to ensure consistency with the hardware and software described. Since variance cannot be precluded entirely, we cannot guarantee full consistency. However, the information in this publication is reviewed regularly and any necessary corrections are included in subsequent editions.

Preface

These operating instructions contain all the information you need for commissioning and operation of a device in the SIMATIC IOT2000 family.

It is intended both for programming and testing personnel who commission the device and connect it with other units (automation systems, programming devices), as well as for service and maintenance personnel who install add-ons or carry out fault/error analyses.

Basic knowledge requirements

Knowledge of personal computers, operating systems and programming is required to understand this manual. General knowledge in the field automation control engineering is recommended.

Scope of validity of this document

These operating instructions apply to the following devices of the device family SIMATIC IOT2000:

- SIMATIC IOT2020
- SIMATIC IOT2040

Scope of this documentation

The device documentation comprises:

- Product information, e.g. "Important notes on your device"
- Quick Install Guide SIMATIC IOT2000
- SIMATIC IOT2000 operating instructions in German and English

Conventions

The following generic terms are used in this documentation:

Generic term	Specific name
Device	SIMATIC IOT2020, SIMATIC IOT2040
Arduino shield	ARDUINO UNO (Rev3)

The term "device" is sometimes used to refer to the SIMATIC IOT2020 and SIMATIC IOT2040.

Figures

This manual contains figures of the described devices. The supplied device may differ in some details from the figures. Within some of the figures, one device is used to represent all devices.

History

The following editions of these operating instructions have been published:

Edition	Comment
09/2016	First edition
10/2016	Second edition, correction to forum login in the section "Software and commissioning"

Table of contents

	Preface	3
1	Overview.....	7
1.1	Product description	7
1.2	Structure of the devices	9
1.2.1	SIMATIC IOT2020	9
1.2.2	SIMATIC IOT2040	10
1.3	Accessories.....	11
2	Safety instructions.....	13
2.1	General safety instructions	13
2.2	Notes on use.....	17
3	Installing and connecting the device	19
3.1	Preparing for installation	19
3.1.1	Checking the delivery.....	19
3.1.2	Identification data of the device	21
3.1.3	Permitted mounting positions and mounting types.....	21
3.2	Mounting the device.....	22
3.2.1	Mounting instructions	22
3.2.2	Mounting on DIN rails	24
3.2.3	Wall mounting	25
3.3	Connecting the device	26
3.3.1	Notes on connecting	26
3.3.2	Connecting the power supply	27
3.3.3	Securing the cables	28
4	Software and commissioning.....	29
5	Expand device	31
5.1	Insert Micro SD card	31
5.2	Install Arduino shield.....	32
5.3	Install Mini PCIe card.....	33
6	Maintaining and repairing the device	35
6.1	Maintenance	35
6.2	Repair information.....	35
6.3	Replace the backup battery	36
6.4	Recycling and disposal	38

7	Technical specifications	39
7.1	Certificates and approvals	39
7.2	Directives and declarations	41
7.2.1	Notes on CE marking	41
7.2.2	ESD guideline	41
7.3	Dimension drawings	44
7.4	Technical data	45
7.4.1	General technical specifications	45
7.4.2	Ambient conditions	47
7.4.3	Power demand of the components	48
7.4.4	Direct current supply (DC)	48
7.5	Hardware descriptions	49
7.5.1	Motherboard	49
7.5.2	External Interfaces	51
7.5.2.1	Power supply	51
7.5.2.2	USB	51
7.5.2.3	Ethernet port	52
7.5.2.4	Serial port (only SIMATIC IOT2040)	52
7.5.3	Internal interfaces	54
7.5.3.1	Arduino shield interfaces	54
7.5.3.2	UART Debug	55
7.5.3.3	Mini PCIe interface	56
7.5.3.4	Micro SD interface	56
A	Technical support	57
A.1	Service and support	57
B	List of abbreviations	59
	Glossary	61
	Index	63

Overview

1.1 Product description

The devices of the SIMATIC IOT family offer a robust, compact and flexible solution with a focus on the IOT environment and round off the SIMATIC IPC product range in the lower output range.



Features

- High degree of ruggedness
- Compact design as per LOGO!
- External RS232/RS422/RS485, Ethernet and USB interfaces
- Internal interfaces for Arduino Shield and Mini PCIe card
- Freely programmable interfaces
- Maintenance-free operation possible

Features

Depending on the industrial area of application, the following SIMATIC IOT devices are available with the following features:

SIMATIC IOT2040

- Intel Quark X1020 processor
- 1 GB RAM
- 2 x Ethernet interfaces
- 2 x RS232/422/485 interface
- Battery-buffered real-time clock

SIMATIC IOT2020

- Intel Quark X1000 processor
- 512 MB RAM
- 1 x Ethernet interface

1.2 Structure of the devices

1.2.1 SIMATIC IOT2020

The following figures show the configuration and interfaces of the SIMATIC IOT2020.

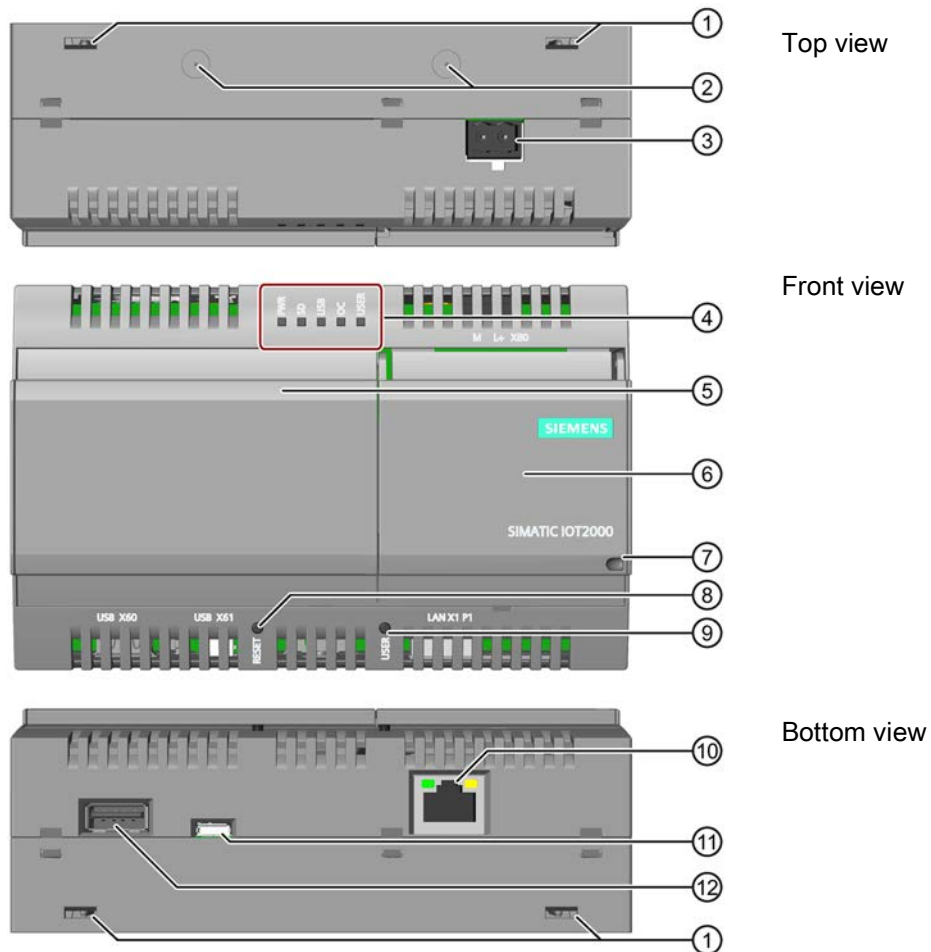

- | | |
|--|----------------------------------|
| ① Openings for push-in lugs for wall mounting | ⑦ Securing device |
| ② Markings for the installation of antennae | ⑧ RESET button for the CPU |
| ③ Power supply connector | ⑨ USER button, programmable |
| ④ LED display, see section "Motherboard (Page 49)" | ⑩ Ethernet interface 10/100 Mbps |
| ⑤ Cover on left | ⑪ USB Type Micro B |
| ⑥ Cover on right | ⑫ USB Type A |

1.2.2 SIMATIC IOT2040

The following figures show the configuration and interfaces of the SIMATIC IOT2040.

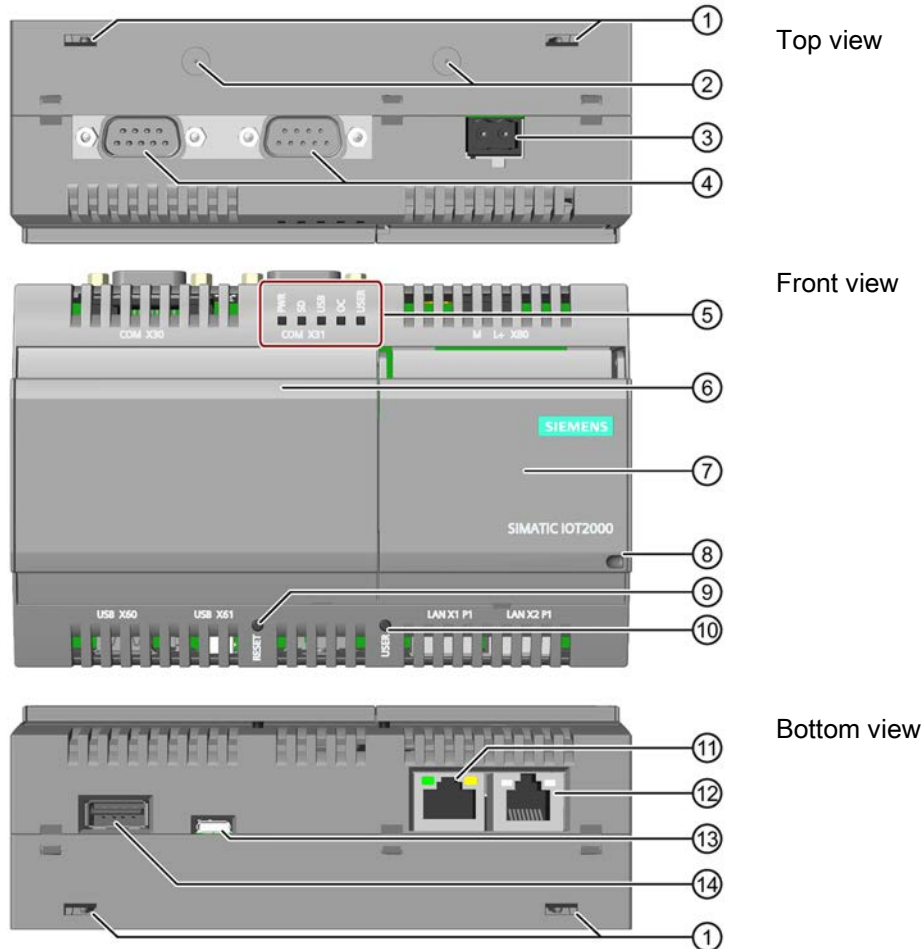

- | | |
|--|--|
| ① Openings for push-in lugs for wall mounting | ⑧ Securing device |
| ② Markings for the installation of antennae | ⑨ RESET button for the CPU |
| ③ Power supply connector | ⑩ USER button, programmable |
| ④ COM interfaces (RS232/422/485) | ⑪ Ethernet interface 10/100 Mbps |
| ⑤ LED display, see section "Motherboard (Page 49)" | ⑫ Ethernet interface 10/100 Mbps, prepared for PoE |
| ⑥ Cover on left | ⑬ USB Type Micro B |
| ⑦ Cover on right | ⑭ USB Type A |

1.3 Accessories

This chapter contains the scope of accessories valid at the time these operating instructions were written. The following accessories are not included in the scope of delivery and can be ordered separately. Additional accessories can be found on the Internet at:

Industry Mall (<https://mall.industry.siemens.com>)

Push-in lugs



Set with 100 push-in lugs for wall mounting

Article number: 3RB1900-0B

Storage media

SIMATIC PC USB flash drive

Article number: 6ES7648-0DC50-0AA0, 6ES7648-0DC60-0AA0

2.1 General safety instructions

 WARNING
Life-threatening voltages are present with an open control cabinet When you install the device in a control cabinet, some areas or components in the open control cabinet may be carrying life-threatening voltages. If you touch these areas or components, you may be killed by electric shock. Switch off the power supply to the cabinet before opening it.

System expansions

NOTICE
Damage through system expansions Device and system expansions may be faulty and can affect the entire machine or plant. The installation of expansions can damage the device, machine or plant. Device and system expansions may violate safety rules and regulations regarding radio interference suppression. If you install or exchange system expansions and damage your device, the warranty becomes void.

For system expansions:

- Only install system expansion devices designed for this device. Contact your technical support team or where you purchased your PC to find out which system expansion devices may safely be installed.
- Observe the information on electromagnetic compatibility (Page 45).

 WARNING
Risk of fire through expansion cards Expansion cards generate additional heat. The device may overheat and cause a fire. Please note the following: <ul style="list-style-type: none">• Observe the safety and installation instructions for the expansion cards.• If in doubt, install the device in an enclosure that is compliant with sections 4.6 and 4.7.3 of the IEC/UL/EN/DIN-EN 60950-1 standard.

NOTICE
Use in the scope of application for the UL61010-2-201
When the device is used in the area of Industrial Control Equipment in accordance with UL61010-2-201, note that the device is classified as "Open Type". A UL61010-2-201 conform enclosure is therefore a mandatory requirement for approval or operation according to UL61010-2-201.
If the device is used in a manner not specified by the manufacturer, the approval is lost and the protection associated with it may be impaired.

Note

Limitation of liability

All technical specifications and approvals of the device only apply if you use expansion components that have a valid CE approval (CE mark). The installation conditions for expansion components in the associated documentation must be observed.

UL approval of the device only applies when the UL-approved components are used according to their "Conditions of Acceptability".

We are not liable for functional limitations caused by the use of third-party devices or components.

NOTICE
The approvals are voided if certain modifications are made
The device approvals are voided if the following modifications are made:
<ul style="list-style-type: none">• The enclosure was physically modified, for example, openings were created to make LEDs on a plug-in card in the device visible.• Cables are routed from the inside out of the device or from the outside into the device, for example, to connect sensors or displays.

Battery and rechargeable battery

WARNING

Risk of explosion and release of harmful substances

Improper handling of lithium batteries can result in an explosion of the batteries.

Explosion of the batteries and the released pollutants can cause severe physical injury. Worn batteries jeopardize the function of the device.

Note the following when handling lithium batteries:

- Replace used batteries in good time; see the section "Replacing the backup battery" in the operating instructions.
- Replace the lithium battery only with an identical battery or types recommended by the manufacturer (order no.: A5E34734290).
- Do not throw lithium batteries into fire, do not solder on the cell body, do not recharge, do not open, do not short-circuit, do not reverse polarity, do not heat above 100°C and protect from direct sunlight, moisture and condensation.

Strong high-frequency radiation

NOTICE

Observe immunity to RF radiation

The device has an increased immunity to RF radiation according to the specifications on electromagnetic compatibility in the technical specifications.

Radiation exposure in excess of the specified immunity limits can impair device functions, result in malfunctions and therefore injuries or damages.

Read the information on immunity to RF radiation in the technical specifications.

ESD Guideline



Electrostatic sensitive devices can be labeled with an appropriate symbol.

NOTICE

Electrostatic sensitive devices (ESD)

When you touch electrostatic sensitive components, you can destroy them through voltages that are far below the human perception threshold.

If you work with components that can be destroyed by electrostatic discharge, observe the ESD Guideline (Page 41).

Industrial Security

Siemens provides products and solutions with industrial security functions that support the secure operation of plants, systems, machines and networks.

In order to protect plants, systems, machines and networks against cyber threats, it is necessary to implement – and continuously maintain – a holistic, state-of-the-art industrial security concept. Siemens' products and solutions only form one element of such a concept.

Customer is responsible to prevent unauthorized access to its plants, systems, machines and networks. Systems, machines and components should only be connected to the enterprise network or the internet if and to the extent necessary and with appropriate security measures (e.g. use of firewalls and network segmentation) in place.

Additionally, Siemens' guidance on appropriate security measures should be taken into account. For more information about industrial security, please visit (<http://www.siemens.com/industrialsecurity>).

Siemens' products and solutions undergo continuous development to make them more secure. Siemens strongly recommends to apply product updates as soon as available and to always use the latest product versions. Use of product versions that are no longer supported, and failure to apply latest updates may increase customer's exposure to cyber threats.

To stay informed about product updates, subscribe to the Siemens Industrial Security RSS Feed under (<http://www.siemens.com/industrialsecurity>).

Disclaimer for third-party software updates

This product includes third-party software. Siemens AG only provides a warranty for updates/patches of the third-party software, if these have been distributed as part of a Siemens software update service contract or officially released by Siemens AG. Otherwise, updates/patches are undertaken at your own risk. You can find more information about our Software Update Service offer on the Internet at Software Update Service (<http://www.automation.siemens.com/mcms/automation-software/en/software-update-service>).

Notes on protecting administrator accounts

A user with administrator privileges has extensive access and manipulation options in the system.

Therefore, ensure there are adequate safeguards for protecting the administrator accounts to prevent unauthorized changes. To do this, use secure passwords and a standard user account for normal operation. Other measures, such as the use of security policies, should be applied as needed.

2.2 Notes on use

NOTICE
Possible functional restrictions in case of non-validated plant operation The device is tested and certified on the basis of the technical standards. In rare cases, functional restrictions can occur during plant operation. Validate the correct functioning of the plant to avoid functional restrictions.

Note

Use in an industrial environment without additional protective measures

This device was designed for use in a normal industrial environment according to IEC 60721-3-3.

Installing and connecting the device

3.1 Preparing for installation

3.1.1 Checking the delivery

Procedure

1. When accepting a delivery, please check the packaging for visible transport damage.
2. If any transport damage is present at the time of delivery, lodge a complaint at the shipping company in charge. Have the shipper confirm the transport damage immediately.
3. Unpack the device at its installation location.
4. Keep the original packaging in case you have to transport the unit again.

Note

Damage to the device during transport and storage

If a device is transported or stored without packaging, shocks, vibrations, pressure and moisture may impact the unprotected unit. A damaged packaging indicates that ambient conditions have already had a massive impact on the device.

The device may be damaged.

Do not dispose of the original packaging. Pack the device during transportation and storage.

5. Check the contents of the packaging and any accessories you may have ordered for completeness and damage.
 - Device
 - DC connecting terminal, already plugged into the device.
 - Inserts

3.1 Preparing for installation

6. If the contents of the packaging are incomplete, damaged or do not match your order, inform the responsible delivery service immediately.

 WARNING
Electric shock and fire hazard due to damaged device A damaged device can be under hazardous voltage and trigger a fire in the machine or plant. A damaged device has unpredictable properties and states. Death or serious injury could occur. Make sure that the damaged device is not inadvertently installed and put into operation. Label the damaged device and keep it locked away. Send off the device for immediate repair.

NOTICE
Damage from condensation If the device is subjected to low temperatures or extreme fluctuations in temperature during transportation, for example in cold weather, moisture could build up on or inside the HMI device (condensation). Moisture causes a short circuit in electrical circuits and damages the device. In order to prevent damage to the device, proceed as follows: <ul style="list-style-type: none">• Store the device in a dry place.• Bring the device to room temperature before starting it up.• Do not expose the device to direct heat radiation from a heating device.• If condensation develops, wait approximately 12 hours or until the device is completely dry before switching it on.

7. Please keep the enclosed documentation in a safe place. It belongs to the device. You need the documentation when you commission the device for the first time.
8. Write down the identification data of the device.

3.1.2 Identification data of the device

The device can be clearly identified with the help of this identification data in case of repairs or theft.

You can find this information on the rating plate. The following illustration shows an example.

Example rating plate:	Enter the identification data in the table below:	
 <p>SIEMENS SIMATIC IOT2040 1P 6ES7 647-0AA00-1YA2 s V-H5A12345</p> <p>FS: 01 03.2016 DC 3.36V 1.4A NEC CLASS 2 MAC-ADDRESS 1: 00-00-00-00-00-00 SERVICE & SUPPORT: www.siemens.com/asis</p> <p>EAC MSIP-REM-SS3-PIC0</p> <p>UL CE LISTED</p> <p>5472909 IND. CONT. EQ. THIS DEVICE COMPLIES WITH PART 15 OF THE FCC RULES. OPERATION IS SUBJECT TO THE FOLLOWING TWO CONDITIONS: (1) THIS DEVICE MUST ACCEPT ANY INTERFERENCE, AND (2) THIS DEVICE MUST ACCEPT ANY INTERFERENCE RECEIVED, INCLUDING INTERFERENCE THAT MAY CAUSE UNDESIRABLE OPERATION. CAN ICES-3 (B)/NMB-3(B)</p> <p>Siemens AG, Gleiwitzer Str. 555, DE-90475 Nuremberg Made in China</p>	Order number	6ES ...
	Serial number	S VP
	Production version	FS
	All existing Ethernet addresses (MAC)	

3.1.3 Permitted mounting positions and mounting types

The device can be attached horizontally or vertically on a DIN rail or to a wall.

Horizontal mounting position, preferred



Vertical mounting position



Take into account the permitted temperature range for operation that depends on the mounting position in accordance with the "Technical specifications (Page 45)" section.

Clearances

Ensure that the following clearances measurements to another component or to a wall of a housing are complied with:

- Below the device: ≥ 50 mm
- Above the device: ≥ 50 mm

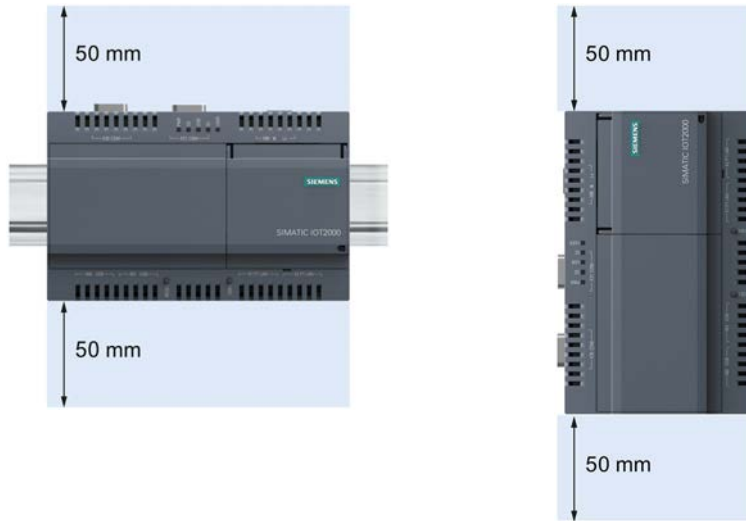

3.2 Mounting the device

3.2.1 Mounting instructions

Note the following:

- The device is approved for operation in closed rooms only.
- For installation in a cabinet, observe the SIMATIC setup guidelines (<http://support.automation.siemens.com/WW/view/de/1064706>) as well as the relevant DIN/VDE requirements or the applicable country-specific regulations.
- When the device is used in the area of Industrial Control Equipment in accordance with UL61010-2-201, note that the device is classified as "Open Type". A UL61010-2-201 conform enclosure is therefore a mandatory requirement for approval or operation according to UL61010-2-201.
- Install all the expansions in the device before mounting the device on a DIN rail or a wall, see section "Expand device (Page 31)".
- To protect the enclosure of the device against unauthorized opening, after installing the expansions you can screw the rear panel of the enclosure to the front panel of the enclosure using two screws. The screws are not included in the scope of delivery. Use only screws of the type WN1452-K30x20-ST-A2F and tighten the screws using a torque of 0.5 Nm.

Fasten securely**NOTICE****Insufficient load carrying capacity**

If the mounting surface for wall mounting does not have a sufficient load-bearing capacity, the device may fall and be damaged.

Ensure that the mounting surface on the wall can bear four times the total weight of the device, including fixing elements.

NOTICE**Incorrect fixing elements**

If you use anchors and screws other than those specified below for wall mounting, safe mounting is not guaranteed. The device can fall and may be damaged.

Use only the anchors and screws specified in the following table.

Material	Bore diameter	Fixing element
Concrete	Select according to the specification of the mounting elements used	<ul style="list-style-type: none"> • Anchor, \varnothing 6 mm, 40 mm long • Screw, \varnothing 4-5 mm, 40 mm long
Plasterboard, (at least 13 mm thick)		Toggle plug, \varnothing 12 mm, 50 mm long
Metal, (at least 2 mm thick)		<ul style="list-style-type: none"> • Screw M4 \times 15 • M4 nut

3.2.2 Mounting on DIN rails

Requirement

- A DIN rail, 35 mm standard profile
The DIN rail is installed at the installation site.

Procedure

Mounting

1. Place the device and rail clip on the upper edge of the standard profile rail at the position shown and push the device down.
2. Swing the rail clips of the device from below via the standard profile rail.
3. Push the device in the direction of the standard profile rail. You will hear the device click into place.

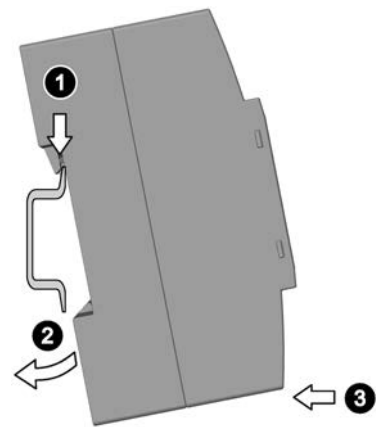

Removing

1. Push down the device until it is released by the rail clips.
2. Swing the device out of the standard profile rail.
3. Lift the device up and off.

3.2.3 Wall mounting

The device is suitable for horizontal or vertical wall mounting.

Requirement

- Four push-in lugs
The push-in lugs must be ordered separately, see section "Accessories (Page 11)"
- Four anchors and four screws

Procedure for mounting

1. Guide a push-in lug through the corresponding opening at the top of the device, as shown
2. Press the push-in lug down.
3. Mark the bore holes, drill the required holes in the wall and fasten the device to the wall using four screws and corresponding anchors.

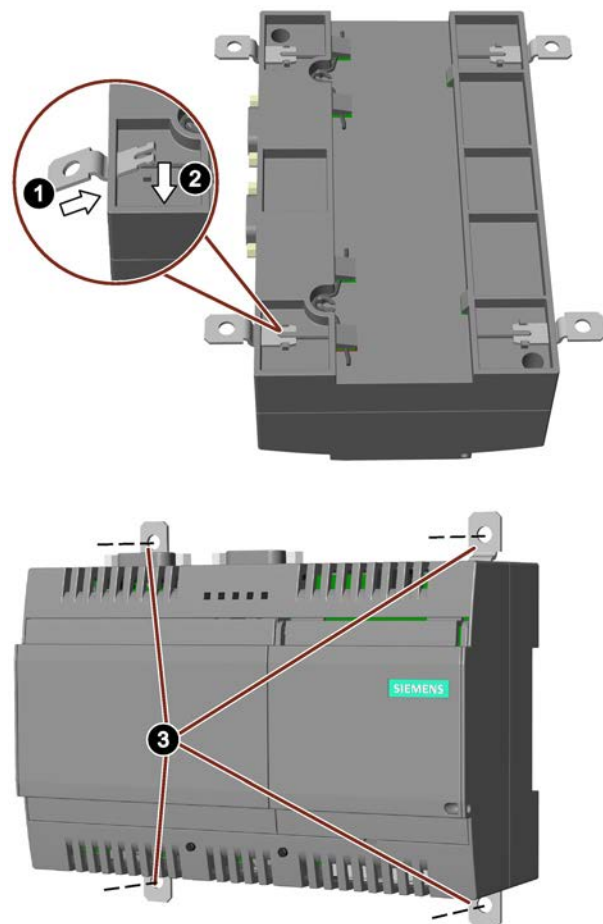

3.3 Connecting the device

3.3.1 Notes on connecting

 WARNING
Risk of lightning strikes
A lightning flash may enter the mains cables and data transmission cables and jump to a person.
Death, serious injury and burns can be caused by lightning.
Take the following precautions:
<ul style="list-style-type: none">• Disconnect the device from the power supply in good time when a thunderstorm is approaching.• Do not touch mains cables and data transmission cables during a thunderstorm.• Keep a sufficient distance from electric cables, distributors, systems, etc.

NOTICE
Fault caused by I/O devices
The connection of I/O devices can cause faults in the device.
The result may be personal injury and damage to the machine or plant.
Note the following when connecting I/O devices:
<ul style="list-style-type: none">• Read the documentation of the I/O devices. Follow all instructions in the documentation.• Only connect I/O devices which are approved for industrial applications in accordance with EN 61000-6-2 and IEC 61000-6-2.• I/O devices that are not hotplug-capable may only be connected after the device has been disconnected from the power supply.

NOTICE
Damage through regenerative feedback
Regenerative feedback of voltage to ground by a connected or installed component can damage the device.
Connected or built-in I/Os, for example, a USB drive, are not permitted to supply any voltage to the device. Regenerative feedback is generally not permitted.

NOTICE
Ferrite required at USB cables
The interference immunity of the device according to the data in the technical specifications is only guaranteed when the cables at USB and micro USB ports are equipped with a ferrite magnet. Use only USB cables equipped with a ferrite magnet.

3.3.2 Connecting the power supply

Note

The device should only be connected to a 9...36 V DC power supply which meets the requirements of safe extra low voltage (SELV) according to IEC/EN/DIN EN/UL 60950-1.

The power supply must meet the requirement NEC Class 2 or LPS according to IEC/EN/DIN EN/UL 60950-1.

Note

The power supply must be adapted to the input data of the device, see chapter "General technical specifications (Page 45)".

If there are voltage peaks on power supply lines, use a protective device in the form of a varistor (MOV) UMOV = U-rated x 1.2 (BLITZDUCTOR BVT AVD 24 (918 422) or compatible).

Requirement

- You are using the supplied terminal.
- A two-core cable with a cable cross-section of 0.75 mm² to 2.5 mm².
- A slotted screwdriver with a 3mm blade.

Procedure

1. Switch off the power supply.
2. Connect the lines to the connecting terminal as shown.
3. Connect the connecting terminal to the connection for the power supply.

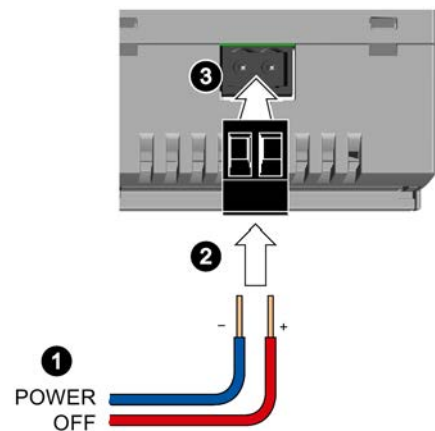

3.3.3 Securing the cables

Use cable ties or cable clamps to secure the connected cables to suitable fixing elements for strain relief.

Make sure that the cables are not crushed by the cable tie or the cable clamps.

Software and commissioning

Operating system and software for the SIMATIC IOT devices are freely programmable and are downloaded from the Micro SD card when the device is booted.

For SIMATIC IOT2040: The device starts with "Secure Boot", which means the SD card with the customer-specific image must be signed accordingly.

Additional information on the topics software, "Secure Boot", commissioning and Micro SD image is available in the SIMATIC IOT2000 Forum.

SIMATIC IOT2000 Forum

To use the SIMATIC IOT2000 Forum, you need a login for online support.

Follow these steps to participate in the Technical Forum:

1. Open the website "Technical Forum (<http://www.siemens.com/automation/forum>)".
2. If you do not yet have a login for online support, click "Register" at the top right of the window and follow the registration instructions.

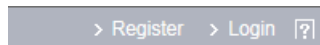

During registration, you enter an alias for the forum, for example. This alias is the pseudonym under which other users can see you and talk to you in the forum.

You will receive a confirmation e-mail after registering successfully.

Expand device

5.1 Insert Micro SD card

Requirement

- The device is disconnected from the power supply.
- Micro SD card that is suitable for industrial use.

Procedure

Installation

NOTICE

Inserting a memory card

If you are using the Micro SD card in a device installed in a system, you must observe the safety regulations for work on electrical systems.

Carefully insert the Micro SD card into the Micro SD holder without applying excess force.

1. Open the cover on the right.
2. Carefully press the Micro SD holder down and lift the holder forwards.
3. Push the Micro SD card correctly aligned into the supporting frame. The contacts of the Micro SD card must point in the direction of the motherboard.
4. Push the supporting frame back and carefully push the supporting frame upwards until it engages.

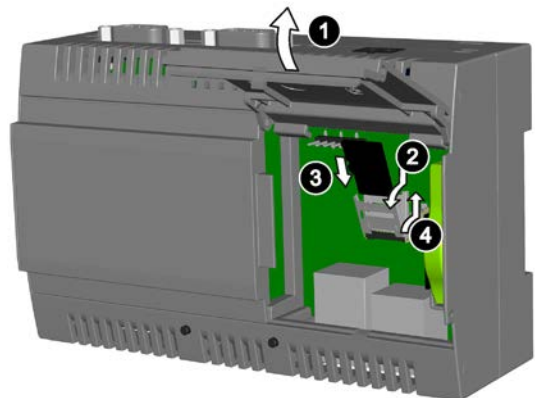

5.2 Install Arduino shield

Requirement

- The device is disconnected from the power supply.
- An Arduino shield

Procedure

NOTICE

Install Arduino shield

Do not under any circumstances insert the Arduino shield incorrectly. Ensure that the contact pins of the Arduino shield connect correctly with the terminal strips of the motherboard.

Arduino shield with operator control or display elements

Some Arduino shields have operator control and display elements. The device loses its approval certificates if you drill or mill openings in the cover in order to make the operator control or display elements of the Arduino shield accessible or visible from outside. In this case, the customer is responsible for the re-approval of the device.

Note

Power consumption

If the power consumption of the Arduino shield is too high, the device will be damaged. Note the information in section "Technical data (Page 45)".

Ambient temperature

The temperature in the housing of the device can be up to 30 °C above the maximum permissible ambient temperature of the device. Make sure that the maximum permissible ambient temperature of the Arduino shield is specified accordingly.

1. Open cover on the right and lift up the cover.

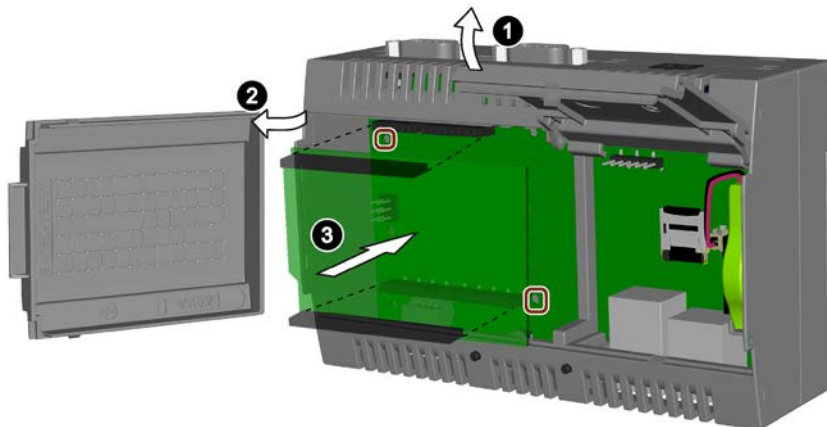

2. Open the cover on the left by slightly raising the cover and lifting it to the left.
3. Insert the Arduino shield into the motherboard. Ensure that the contact pins of the Arduino shield fit perfectly on the contact strips of the motherboard and that the components of the Arduino shield do not touch the components of the motherboard.

Note

Only use fixing elements made from plastic.

You can use the four boreholes in the motherboard to additionally fasten the Arduino shield on the motherboard. Two of the boreholes are shown in the figure above. Use only fixing elements made from plastic, not metallic or conductive materials.

5.3 Install Mini PCIe card

You can install a Mini PCIe card in a device of the type IOT2000.

Note**Power consumption**

If the power consumption of the Mini PCIe card is too high, the device will be damaged.

Note the information in section "Technical data (Page 45)".

Ambient temperature

The temperature in the housing of the device can be up to 30 °C above the maximum permissible ambient temperature of the device.

Make sure that the maximum permissible ambient temperature of the Mini PCIe- card is specified accordingly.

Requirement

- The device is disconnected from the power supply.
- A Mini PCIe card

 **CAUTION****Risk of burns due to hot components**

The motherboard and internal components can get hot during operation. Motherboard and internal components will only cool down slowly after the device has been switched off.

To avoid getting burned, wait a while after switching off the power supply. Be very careful when opening the enclosure and removing the motherboard.

Procedure

The following example describes the installation of a Mini PCIe WLAN card, including mounting of the antenna jacks. If you install a different Mini PCIe card, the work steps 4, 5 and 7 are not required.

When the enclosure is secured with two screws at the rear panel, remove the two screws.

Remove the battery, see section "Replace the backup battery (Page 36)".

Then follow these steps:

1. Loosen the front panel of the housing from the rear panel of the housing. Carefully press with the blade of a flat-blade screwdriver in the marked recesses and carefully pull on the appropriate place on the front panel of the enclosure.
2. Remove the front panel of the enclosure.
3. Remove the motherboard.
4. Drill the bushings for the antenna sockets with a corresponding diameter at the markings shown.
5. Install the antenna sockets in the enclosure.
6. Insert the Mini PCIe card in the Mini PCIe interface on the motherboard from below as illustrated.
7. Connect the antenna cables to the Mini PCIe card.

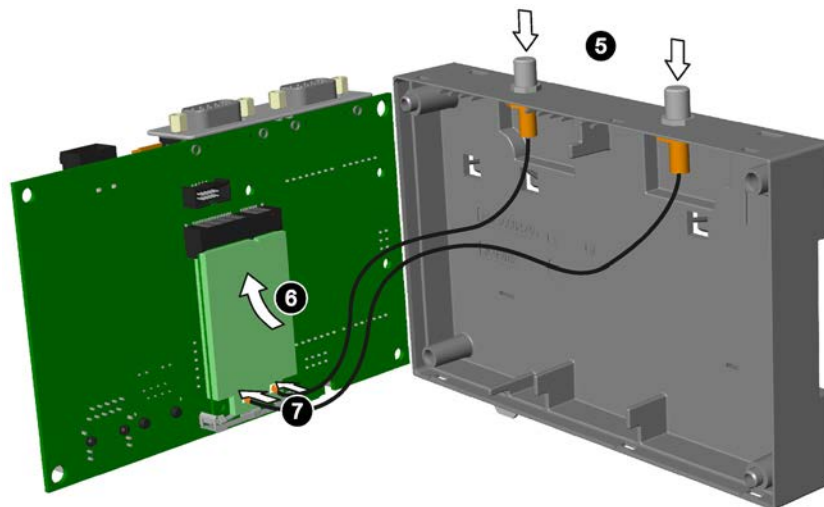
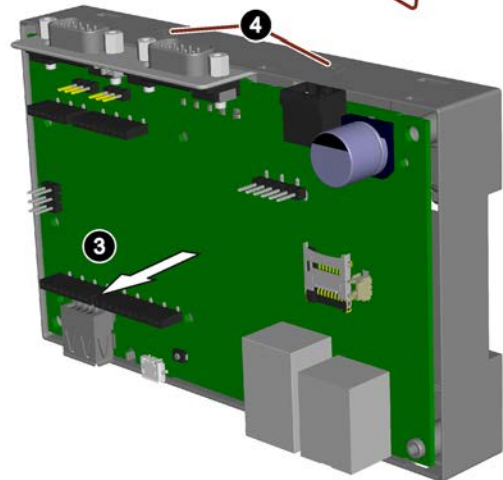
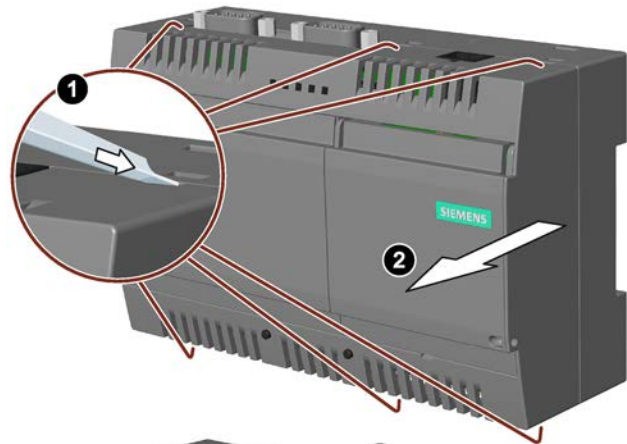

Then install the motherboard again and close the housing.

Maintaining and repairing the device

6.1 Maintenance

To retain a high level of system availability, or devices with a back-up battery, we recommend the preventative replacement of the back-up battery at replacement intervals of 5 years.

6.2 Repair information

Carrying out repairs

Only qualified personnel are permitted to repair the device. Contact your local representative, see section "Service and support (Page 57)".

 WARNING
<p>Unauthorized opening and improper repairs on the device may result in substantial damage to equipment or endanger the user.</p> <ul style="list-style-type: none"> • Always disconnect the power plug before you open the device. • Only install system expansion devices designed for this device. If you install other expansion devices, you may damage the device or violate the safety requirements and regulations on RF suppression. Contact your technical support team or where you purchased your PC to find out which system expansion devices may safely be installed.

If you install or exchange system expansions and damage your device, the warranty becomes void.

 CAUTION
<p>Electrostatic sensitive devices (ESD)</p> <p>The device contains electronic components which are destroyed by electrostatic charges. This can result in malfunctions and damage to the machine or plant.</p> <p>Make sure you take precautionary measures even when you open the device, for example, when opening device doors, device covers or the housing cover. For more information, refer to the chapter "ESD Guideline (Page 41)"</p>

Limitation of liability

All technical specifications and approvals of the device only apply if you use expansion components that have a valid CE approval (CE mark). The installation instructions for expansion components in the associated documentation must be observed.

6.3 Replace the backup battery

UL approval of the device only applies when the UL-approved components are used according to their "Conditions of Acceptability".

We are not liable for functional limitations caused by the use of third-party devices or components.

6.3 Replace the backup battery

This chapter applies to the device IOT2040, which has a back-up battery.

Prior to replacement

 WARNING
Risk of explosion and release of harmful substances Improper handling of lithium batteries can result in an explosion of the batteries. Explosion of the batteries and the released pollutants can cause severe physical injury. Worn batteries jeopardize the function of the device. Note the following when handling lithium batteries: <ul style="list-style-type: none">• Replace the battery every 5 years.• Replace the lithium battery only with the type recommended by the manufacturer. The article number is A5E34734290.• Do not throw lithium batteries into fire, do not solder on the cell body, do not recharge, do not open, do not short-circuit, do not reverse polarity, do not heat above 100°C and protect from direct sunlight, moisture and condensation.
NOTICE
Disposal of batteries and rechargeable batteries Batteries and rechargeable batteries do not belong in domestic garbage. The user is legally obliged to return used batteries and rechargeable batteries. Used batteries and rechargeable batteries pollute the environment as special waste. You as a user are liable to prosecution if you do not properly dispose of batteries and rechargeable batteries. Please observe the following when disposing of batteries and rechargeable batteries: <ul style="list-style-type: none">• Dispose of used batteries and rechargeable batteries separately as hazardous waste in accordance with local regulations.• You can return used batteries and rechargeable batteries to public collection points and wherever batteries or rechargeable batteries of the type in question are sold.• Label the battery container "Used batteries and rechargeable batteries".

Requirement

- The device is disconnected from the power supply.
- A replacement battery with the article number A5E34345932 is available.

Procedure

NOTICE

The time is lost after 30 seconds

The time will be deleted if it takes you longer than 30 seconds to replace the battery. The device is no longer synchronous. Time-controlled programs will no longer run or will run at the wrong time. This may damage the plant.

Reset the time for the device.

1. Open the cover on the right.
2. Pull the plug of the battery cable from the motherboard.
3. Remove the battery from the battery box.

Insert the replacement battery, plug in the battery cable on the motherboard and close the cover on the right.

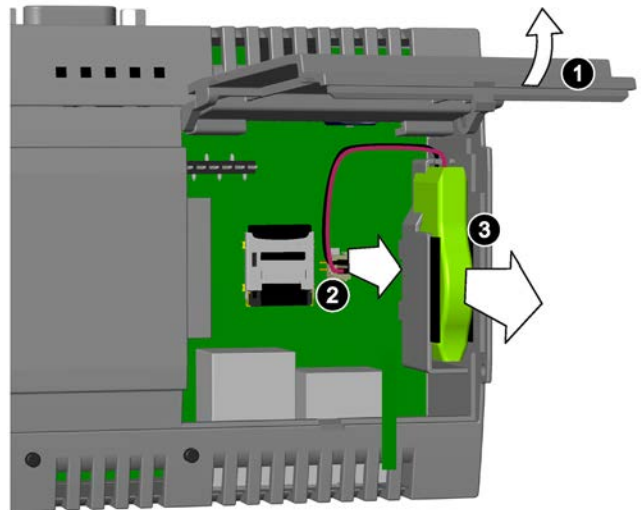

6.4 Recycling and disposal



Marking according to WEEE guideline. Do not discard the device with your household waste. Observe the local legal guidelines for disposal. Alternatively, you can use a certified disposal service company.

Technical specifications

7.1 Certificates and approvals

NOTICE
<p>The approvals are voided if certain modifications are made</p> <p>The device approvals are voided if the following modifications are made:</p> <ul style="list-style-type: none"> • An Arduino shield or a Mini PCIe card was installed. • The enclosure was physically modified, for example, openings were created to make LEDs on a plug-in card in the device visible. • Cables are routed from the inside out of the device or from the outside into the device, for example, to connect sensors or displays.



The device meets the guidelines listed in the following sections.

EU Declaration of Conformity

The associated declaration of conformity is available on the Internet at the following address:
 EU Declaration of Conformity
<https://support.industry.siemens.com/cs/ww/en/ps/16739/cert>.

ISO 9001 certificate

The Siemens quality management system for our entire product creation process (development, production and sales) meets the requirements of ISO 9001.

This has been certified by the TÜV Rheinland.

Software license agreements

If the device is supplied with preinstalled software, you must observe the corresponding license agreements.

UL approval



The following approvals are available for the device:

- Underwriters Laboratories (UL) in accordance with standard UL61010-2-201 (IND.CONT.EQ), File E472609
- Canadian National Standard CAN/CSA-C22.2 No. 142 and CAN/CSA-C22.2 No. 61010-2-201

FCC and Canada

USA	
Federal Communications Commission Radio Frequency Interference Statement	This equipment has been tested and found to comply with the limits for a Class A digital device, pursuant to Part 15 of the FCC Rules. These limits are designed to provide reasonable protection against harmful interference when the equipment is operated in a commercial environment. This equipment generates, uses, and can radiate radio frequency energy and, if not installed and used in accordance with the instruction manual, may cause harmful interference to radio communications. Operation of this equipment in a residential area is likely to cause harmful interference in which case the user will be required to correct the interference at his own expense.
Shielded Cables	Shielded cables must be used with this equipment to maintain compliance with FCC regulations.
Modifications	Changes or modifications not expressly approved by the manufacturer could void the user's authority to operate the equipment.
Conditions of Operations	This device complies with Part 15 of the FCC Rules. Operation is subject to the following two conditions: (1) this device may not cause harmful interference, and (2) this device must accept any interference received, including interference that may cause undesired operation.
CANADA	
Canadian Notice	This Class A digital apparatus complies with Canadian ICES-003 (A).
Avis Canadien	Cet appareil numérique de la classe A est conforme à la norme NMB-003 (A) du Canada.

RCM AUSTRALIA/NEW ZEALAND



This product meets the requirements of the standard EN 61000-6-4:2007 Generic standards – Emission standard for industrial environments.

Identification for Eurasian Customs Union



- EAC (Eurasian Conformity)
- Customs union of Russia, Belarus and Kazakhstan
- Declaration of conformity according to Technical Regulations of the Customs Union (TR CU)

KOREA



This product satisfies the requirement of the Korean Certification (KC Mark).

이 기기는 업무용(A급) 전자파 적합기기로서 판매자 또는 사용자는 이 점을 주의하시기 바라며 가정 외의 지역에서 사용하는 것을 목적으로 합니다.

7.2 Directives and declarations

7.2.1 Notes on CE marking

Electromagnetic compatibility

This product meets the requirements of EU Directive 2014/30/EU "Electromagnetic Compatibility".

The device is designed for the following areas of application corresponding to the CE marking:

Scope of application	Requirements for	
	Interference emission	Immunity to interference
Industrial area	EN 61000-6-4:2007 +A1:2011	EN 61000-6-2:2005

7.2.2 ESD guideline

What does ESD mean?

An electronic module is equipped with highly integrated components. Due to their design, electronic components are highly sensitive to overvoltage and thus to the discharge of static electricity. Such electronic components or modules are labeled as electrostatic sensitive devices.

The following abbreviations are commonly used for electrostatic sensitive devices:

- ESD – Electrostatic sensitive device
- ESD – Electrostatic Sensitive Device as a common international designation

Electrostatic sensitive devices can be labeled with an appropriate symbol.



NOTICE

Damage to ESD from touch

Electrostatic sensitive devices, ESD, can be destroyed by voltages which are far below the human perception limit. If you touch a component or electrical connections of a module without discharging any electrostatic energy, these voltages may arise.

The damage to a module by an overvoltage can often not be immediately detected and only becomes evident after an extended period of operation. The consequences are incalculable and range from unforeseeable malfunctions to a total failure of the machine or system.

Avoid touching components directly. Make sure that persons, the workstation and the packaging are properly grounded.

Charge

Every person without a conductive connection to the electrical potential of his/her surroundings can be electrostatically charged.

The material with which this person comes into contact is of particular significance. The figure shows the maximum electrostatic voltages with which a person is charged, depending on humidity and material. These values conform to the specifications of IEC 61000-4-2.

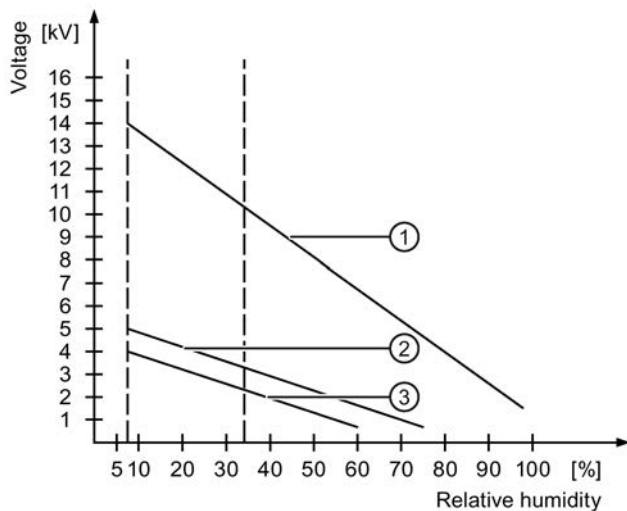

- ① Synthetic materials
- ② Wool
- ③ Antistatic materials such as wood or concrete

NOTICE
Grounding measures
There is no equipotential bonding without grounding. An electrostatic charge is not discharged and may damage the ESD.
Protect yourself against discharge of static electricity. When working with electrostatic sensitive devices, make sure that the person and the workplace are properly grounded.

Protective measures against discharge of static electricity

- Disconnect the power supply before you install or remove modules which are sensitive to ESD.
- Pay attention to good grounding:
 - When handling electrostatic sensitive devices, make sure that persons, the workstation and devices, tools and packaging used are properly grounded. This way you avoid static discharge.
- Avoid direct contact:
 - As a general rule, do not touch electrostatic sensitive devices, except in the case of unavoidable maintenance work.
 - Hold the modules at their edge so that you do not touch the connector pins or conductor paths. This way, the discharge energy does not reach and damage the sensitive components.
 - Discharge your body electrostatically before you take a measurement at a module. Do so by touching grounded metallic parts. Always use grounded measuring instruments.

7.3 Dimension drawings

The following figures show the dimension drawings of the type IOT2000.

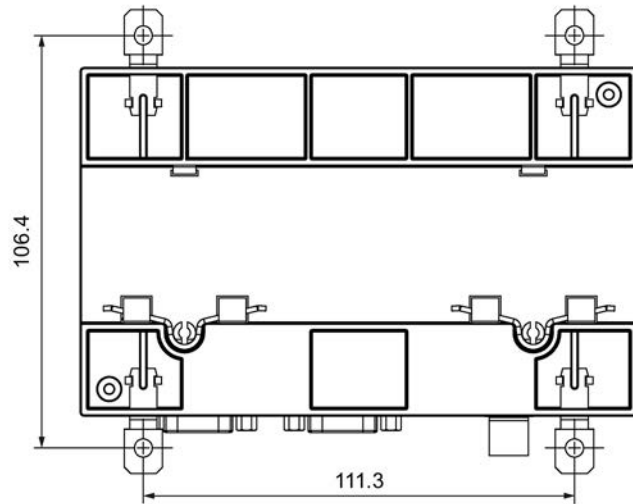
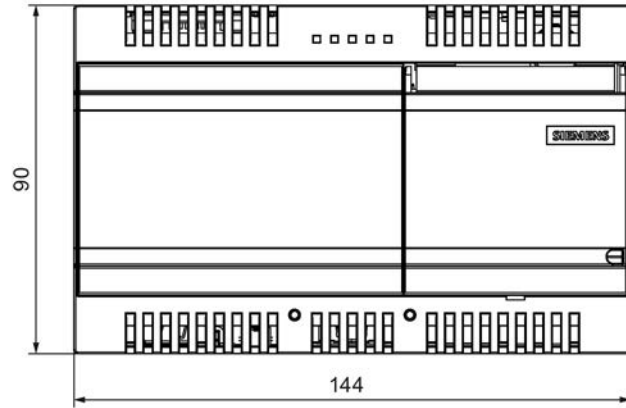
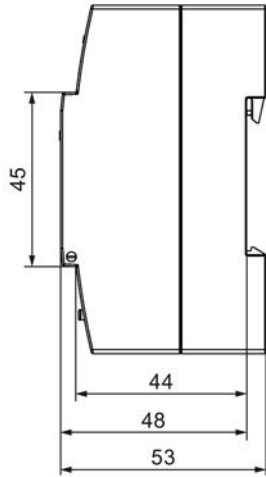

All dimensions in mm.

7.4 Technical data

7.4.1 General technical specifications

General technical specifications

Article number	See order documents
Weight without mounting brackets	<ul style="list-style-type: none"> • SIMATIC IOT2020: approx. 200 g • SIMATIC IOT2040: approx. 230 g
Power supply ¹	DC 9...36 V, no galvanic isolation
Brief voltage interruption in accordance with Namur	Up to 5 ms buffer time at 24 V DC and full load ² Max. 10 events per hour; recovery time at least 10 s
Current consumption	Max. 1.4 A
Noise emission	< 40 dB(A) according to DIN 45635-1
Degree of protection	IP20 according to IEC 60529
Quality assurance	In accordance with ISO 9001

¹ The device should only be connected to a power supply which meets the requirements of safe extra low voltage (SELV) according to IEC/EN/DIN EN/UL 60950-1. The power supply must meet the requirement NEC Class 2 or LPS according to the IEC/EN/DINEN/UL 60950-1.

² In the event of low supply voltage, the buffer time is reduced

Electromagnetic compatibility

Immunity with regard to conducted interference on the supply lines	± 2 kV according to IEC 61000-4-4; burst ± 1 kV according to IEC 61000-4-5; asymmetrical surge
Noise immunity on signal lines	± 1 kV according to IEC 61000-4-4; burst; length < 30 m ± 2 kV according to IEC 61000-4-4; burst; length > 30 m ± 2 kV according to IEC 61000-4-5; surge; length > 30 m
Immunity to discharges of static electricity	± 4 kV contact discharge in accordance with IEC 61000-4-2 ± 8 kV air discharge in accordance with IEC 61000-4-2
Immunity to RF interference	10 V/m, 80 MHz to 1 GHz, 80% AM in accordance with IEC 61000-4-3 3 V/m, 1.4 to 2 GHz, 80% AM in accordance with IEC 61000-4-3 1 V/m, 2 to 2.7 GHz, 80% AM in accordance with IEC 61000-4-3 10 V, 150 KHz to 80 MHz, 80% AM in accordance with IEC 61000-4-6

If there are voltage peaks on power supply lines, use a protective device in the form of a varistor (MOV) UMOV = U-rated x 1.2 (BLITZDUCTOR BVT AVD 24 (918 422) or compatible).

Motherboard

Processor	<ul style="list-style-type: none"> SIMATIC IOT2020: Intel Quark X1000, 400 MHz SIMATIC IOT2040: Intel Quark X1020, 400 MHz
RAM	<ul style="list-style-type: none"> SIMATIC IOT2020: 512 MB SIMATIC IOT2040: 1 GB
BIOS SPI Flash	8 MB
Micro SD	Slot for one Micro SD card
Expansion slots	1 x Arduino shield
	1 x mini PCIe for PCIe cards 30 x 50.59 mm or 30 x 26.8 mm via adapter

Interfaces

All devices of the type SIMATIC IOT2000	
USB Type A, X60	USB 2.0 host, high current, max. 2.5 W/500 mA
USB Typ Micro B, X61	USB device interface
LAN interface X1 P1, RJ45 ¹	SOC LAN controller
Additionally with SIMATIC IOT2040	
LAN interface X2 P1, RJ45 ³	SOC LAN controller
COM X30, X31	<ul style="list-style-type: none"> RS 232 ², max. 115 Kbps, D-sub connector, 9-pin RS 422 ^{2 3}, max. 115 Kbps, D-sub connector, 9-pin RS 485 ^{2 3}, max. 115 Kbps, D-sub connector, 9-pin Maximum permitted cable length at the RS 485: 30 m Maximum permitted cable length at the other COM ports: 1000 m

- ¹ For unique labeling, the LAN interfaces are numbered on the enclosure. The numbering by the operating system can differ.
- ² You can use any COM port as an RS 232, RS422 or RS 485 interface through the software-controlled interface parameter assignment. Possible parameters: "Auto-flow-control", "Onboard termination", "Half-duplex" or "Full-duplex"
- ³ Termination can be set with the software.

Additional information on parameter assignment is available in the SIMATIC IOT2000-Forum, see section "Software and commissioning (Page 29)".

7.4.2 Ambient conditions

Climatic ambient conditions

The temperature values have been checked in accordance with IEC 60068-2-1, IEC 60068-2-2 and IEC 60068-2-14. Permitted mounting positions, see section "Permitted mounting positions and mounting types (Page 21)".

Ambient temperature	
• Operation	0 ... 50 °C *
• Storage/transport	-20 ... 70 °C
Gradient	
• Operation	Max. 10 °C/h
• Storage	20 °C/h, no condensation
Relative humidity , tested in accordance with IEC 60068-2-78, IEC 60068-2-30	
• Operation	5 ... 85% at 30°C, no condensation
• Storage/transport	5 ... 95 % at 25/55 °C, no condensation
Atmospheric pressure	
• Operation	1080 ... 795 hPa, corresponds to an elevation of -1000 m to 2000 m
• Storage/transport	1080 to 660 hPa, corresponds to an elevation of -1000 to 3500 m

* Also note the following section "Power consumption of the components".

Mechanical ambient conditions

Vibration resistance , tested in accordance with IEC 60068-2-6	
• Operation	Vibration load 1g, 10 cycles per axle: <ul style="list-style-type: none"> • 5 to 8.4 Hz, deflection 3.5 mm • 8.4 to 200 Hz, acceleration 9.8 m/s²
• Storage/transport	<ul style="list-style-type: none"> • 5 to 8.4 Hz: Deflection 3.5 mm • 8.4 Hz to 500 Hz: Acceleration 9.8 m/s²
Impact resistance , tested in accordance with IEC 60068-2-27	
• Operation	150 m/s ² , 11 ms
• Storage/transport	250 m/s ² , 6 ms

7.4.3 Power demand of the components

Maximum power consumption of the auxiliary components

The information in the table below applies to the horizontal mounting position of the device at an ambient temperature of 50 °C.

Auxiliary components	Maximum permitted power consumption			Maximum total power
	+5 V	+3.3 V	+1.5 V	
All components				6 W ³
Arduino shield				Permitted power distribution: <ul style="list-style-type: none"> • Arduino shield: 4 W, Mini PCIe card: 0 W, USB: 2.5 W • Arduino shield: 2 W, Mini PCIe card: 1 W, USB: 2.5 W • Arduino shield: 0 W, Mini PCIe card: 2 W, USB: 2.5 W
Mini PCIe card	--	1.5 A ¹	0.3 A ²	
USB 2.0 high current	500 mA	--	--	

¹ May amount to maximum 3.0 A for up to 100 ms at start-stop torque of device

² May amount to maximum 1.2 A for up to 100 ms at start-stop torque of device

³ With maximum total power, the permissible ambient temperature for the vertical mounting position is reduced to 45 °C

Note

Device can overheat!

The power supply cannot make unlimited power available. The auxiliary components consume energy and produce heat.

The device may overheat. The device and the auxiliary components may be damaged.

7.4.4 Direct current supply (DC)

Technical specifications

Input voltage	DC 9...36 V
Power consumption	max. 10 W

Typical power consumption

	Power consumption (at a rated voltage of 24 V)
Basic device	3.5 W
Arduino shields	See section "Power demand of the components (Page 48)"
USB ports	
Expansion cards	

7.5 Hardware descriptions

7.5.1 Motherboard

The following figures show the motherboard of the SIMATIC IOT2040. The interfaces X30, X31 and X2 are not present in SIMATIC IOT2020.

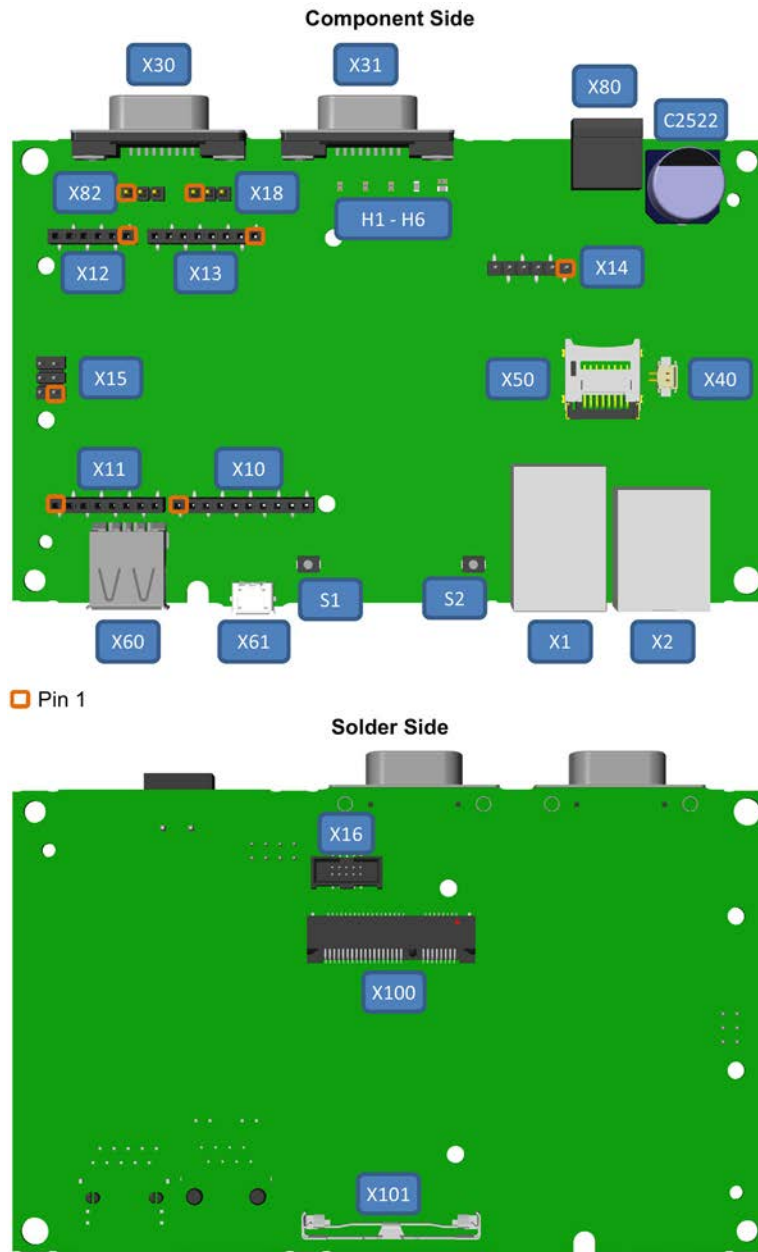

Component/interface	Description / inscription		Meaning, comment
H1	LEDs	PWR	Power (green)
H2		SD	Micro SD card active (green)
H3		USB	USB Power (5 V) is available (green)
H4		OC	OverCurrent (red)
H5/H6 *		USER	User LED (green/red*/orange*), programmable
S1	RESET		For a reset of the CPU
S2	USER		Status can be queried with programming
X1	Ethernet1		
X2	Ethernet2 ready for PoE		
X30, X31	COM D-Sub9		
X60	USB A		
X61	USB B Micro		
X14	UART Debug		
X40	Battery-Con		
X50	µSD slot		
X11, X13	Arduino, 8-pin (2x)		
X10	Arduino, 10-pin		
X12	Arduino, 6-pin		
X15	ICSP		Part of Arduino Interface
X16	JTAG Internal		
X80	Power supply		
X18	Jumper 3 pin SMD		Jumper defines IO voltage for Arduino shield: <ul style="list-style-type: none"> • Jumper on pins 1-2: 5 V • Jumper on pins 2-3: 3.3 V
X100	MiniPCIe Con.		
X101	Latch		
X82	VIN Separation (power supply, 9...36 V DC)		Jumper defines VIN connection to the Arduino shield: <ul style="list-style-type: none"> • Jumper on pins 1-2: VIN is connected to the Arduino shield • Jumper on pins 2-3: VIN is not connected to the Arduino shield

* The LED H6 is only available with SIMATIC IOT2040.

7.5.2 External Interfaces

7.5.2.1 Power supply

Plug connector, 2-pin

Name of interface on the device: X80



Pin	Assignment
1	GND (M)
2	+9...36 V DC (L+)

7.5.2.2 USB

USB socket type A

Name of interface on the device: X60

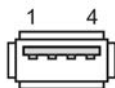

Pin	Assignment
1	+5 VDC, out (max. 500 mA)
2	USB-DN
3	USB-DP
4	GND

USB socket Type Micro B

Name of interface on the device: X61

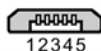

Pin	Assignment
1	-
2	USB-DN
3	USB-DP
4	-
5	GND

7.5.2.3 Ethernet port

RJ45 socket

Name of interface on the device: X1 P1 LAN, X2 P1 LAN

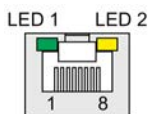

Pin	Short description	Meaning
1	BI_DA+	Bidirectional data A+, input/output
2	BI_DA-	Bidirectional data A-, input/output
3	BI_DB+	Bidirectional data B+, input/output
4	BI_DC+	Bidirectional data C+, input/output
5	BI_DC-	Bidirectional data C-, input/output
6	BI_DB-	Bidirectional data B-, input/output
7	BI_DD+	Bidirectional data D+, input/output
8	BI_DD-	Bidirectional data D-, input/output

LED	Short description	Meaning
1	LED 1	Off: 10 Mbps Lit green: 100 Mbps
2	LED 2	Off: Cable not connected Lights up yellow: Connection established Flashes: Data transfer active

7.5.2.4 Serial port (only SIMATIC IOT2040)

D-sub socket, 9-pin, with screw lock

Name of interface on the device: X30 COM, X31 COM

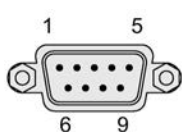

RS 232
RS 422
RS 485

Assignment RS 232

Pin	Short description	Meaning
1	DCD	Data carrier detect (I)
2	RxD	Received data (I)
3	TxD	Transmitted data (O)
4	DTR	Data terminal ready (O)
5	M	Ground
6	DSR	Data set ready (I)
7	RTS	Request to send (O)
8	CTS	Clear to send (I)
9	RI	Incoming call (I)

Assignment RS 422

Pin	Short description	Meaning
1	TX-	Transmitted data - (O) for full-duplex mode
2	TX+	Transmitted data + (O) for full-duplex mode
3	RX+	Receive data + (I) for full-duplex mode
4	RX-	Receive data - (I) for full-duplex mode
5	M	Signal ground
6	nc	
7	nc	
8	nc	
9	nc	

Assignment RS 485

Pin	Short description	Meaning
1	Data-	Transmit / receive data - (I/O) for half-duplex mode
2	Data+	Transmit / receive data+ (I/O) for half-duplex mode
3	nc	
4	nc	
5	M	Signal ground
6	nc	
7	nc	
8	nc	
9	nc	

7.5.3 Internal interfaces

7.5.3.1 Arduino shield interfaces

The tables below show the pin assignment of the interfaces of the Arduino shield, depending on the operating mode.

The position of the interfaces and Pin 1 of the respective interface is available in section "Motherboard (Page 49)".

X10

Pin	Operating mode						
	DIGITAL	ANALOG	POWER	SERIAL	SPI	I2C	PWM
1	8						
2	9						X
3	10				SS		X
4	11				MOSI		X
5	12				MISO		
6	13				SCK		
7			GND				
8							
9	18	A4				SDA	
10	19	A5				SCL	

X11

Pin	Operating mode						
	DIGITAL	ANALOG	POWER	SERIAL	SPI	I2C	PWM
1	0			RxD			
2	1			TxD			
3	2						
4	3						X
5	4						
6	5						X
7	6						X
8	7						

X12

Pin	Operating mode						
	DIGITAL	ANALOG	POWER	SERIAL	SPI	I2C	PWM
1	14	A0					
2	15	A1					
3	16	A2					

Pin	Operating mode						
	DIGITAL	ANALOG	POWER	SERIAL	SPI	I2C	PWM
4	17	A3					
5	18	A4				SDA	
6	19	A5				SCL	

X13

Pin	Operating mode						
	DIGITAL	ANALOG	POWER	SERIAL	SPI	I2C	PWM
1							
2			IOREF				
3			RESET				
4			3,3 V				
5			5 V				
6			GND				
7			GND				
8			VIN				

X15 (ICSP)

Pin	Operating mode						
	DIGITAL	ANALOG	POWER	SERIAL	SPI	I2C	PWM
1	12				MISO		
2			5 V				
3	13				SCK		
4	11						
5			RESET		MOSI		
6			GND				

7.5.3.2 UART Debug

X14

Pin	Assignment
1	GND
2	RTS_N
3	n. c.
4	RxD
5	TxD
6	CTS_N

7.5.3.3 Mini PCIe interface

Pin	Signal Name		Pin	Signal Name
51	W_DISABLE2#		52	+3.3 V _{aux}
49	Reserved		50	GND
47	Reserved		48	+1.5 V
45	Reserved		46	LED_WPAN#
43	GND		44	LED_WLAN#
41	+3.3V _{aux}		42	LED_WWAN#
39	+3.3V _{aux}		40	GND
37	GND		38	USB_D+
35	GND		36	USB_D-
33	PETp0		34	GND
31	PETn0		32	SMB_DATA
29	GND		30	SMB_CLK
27	GND		28	+1.5V
25	PERp0		26	GND
23	PERn0		24	+3.3V _{aux}
21	GND		22	PERST#
19	Reserved (UIM_C4)		20	W_DISABLE1#
17	Reserved (UIM_C8)		18	GND
Nose				
15	GND		16	UIM_VPP
13	REFCLK+		14	UIM_RESET
11	REFCLK-		12	UIM_CLK
9	GND		10	UIM_DATA
7	CLKREQ#		8	UIM_PWR
5	COEX2		6	1.5 V
3	COEX1		4	GND
1	WAKE#		2	3.3 V _{aux}

7.5.3.4 Micro SD interface

Pin	Abbreviation	Function
1	Dat2	Data line bit 2
2	Dat3	Card Detect / data line bit 3
3	CMD	Command Line
4	Vdd	Voltage supply 2.7–3.6 V
5	Clk	Clock input
6	GND	Signal Ground
7	Dat0	Data line bit 0
8	Dat1	Data line bit 1

Technical support

A.1 Service and support

You can find additional information and support for the products described on the Internet at the following addresses:

- Technical support (<https://support.industry.siemens.com>)
- Support request form (<http://www.siemens.com/automation/support-request>)
- After Sales Information System SIMATIC IPC/PG (<http://www.siemens.com/asis>)
- SIMATIC Documentation Collection (<http://www.siemens.com/simatic-tech-doku-portal>)
- Your local representative
(<http://www.automation.siemens.com/mcms/aspa-db/en/Pages/default.aspx>)
- Training center (<http://sitrain.automation.siemens.com/sitrainworld/?AppLang=en>)
- Industry Mall (<https://mall.industry.siemens.com>)

When contacting your local representative or Technical Support, please have the following information at hand:

- MLFB of the device
- BIOS version for industrial PC or image version of the device
- Other installed hardware
- Other installed software

Tools & downloads

Please check regularly if updates and hotfixes are available for download to your device. The download area is available on the Internet at the following link:

After Sales Information System SIMATIC IPC/PG (<http://www.siemens.com/asis>)

B

List of abbreviations

ACPI	Advanced Configuration and Power Interface	
BIOS	Basic Input Output System	
CE	Communauté Européenne	
COM	Communications Port	Term for the serial interface
CPU	Central Processing Unit	CPU
CSA	Canadian Standards Association	Canadian organization for tests and certifications according to national or binational standards
CTS	Clear To Send	Clear to send
DC	Direct Current	DC current
DCD	Data Carrier Detect	Data carrier signal detection
DQS	Deutsche Gesellschaft zur Zertifizierung von Qualitätsmanagement mBH	
DSR	Data Set Ready	Ready for operation
DTR	Data Terminal Ready	Data terminal is ready
ESD	Components sensitive to electrostatic charge	
EN	European standard	
ESD	Electrostatic Sensitive Device	Electrostatic Sensitive Devices
	Electrostatic discharge	Electrostatic discharge
GND	Ground	Chassis ground
IDE	Integrated Device Electronics	
IEC	International Electrical Commission	
LAN	Local Area Network	Computer network that is limited to a local area.
LED	Light Emitting Diode	Light emitting diode
LPS	Limited Power Source	
MAC	Media access control	Media access control
MLFB	Machine-readable product designation	
PC	Personal computer	
PCIe	Peripheral Component Interconnect express	High-speed serial, differential full-duplex PtP interface with high data rate.
PG	Programming device	
RI	Ring Input	Incoming call
RTS	Request to send	Request to send

RxD	Receive Data	Data transfer signal
SELV	Safety Extra Low Voltage	Safety extra low voltage
UEFI	Unified Extensible Firmware Interface	
UL	Underwriters Laboratories Inc.	US organization for testing and certification according to national or binational standards.
USB	Universal Serial Bus	

Glossary

CE marking

Communauté Européene: The CE symbol confirms the conformity of the product with all applicable EC directives such as the EMC Directive.

COM interface

The COM interface is a serial V.24 interface. The interface is suitable for asynchronous data transfer.

Distribution framework

Exemplary reference distribution "Poky" of Embedded Linux (see "Yocto" and "Poky").

Drivers

Program parts of the operating system. They adapt user program data to the specific formats required by I/O devices such as hard disk, printers, and monitors.

Embedded Linux

Linux for industrial, embedded systems (see "Yocto" and "Poky").

ESD Guideline

Guideline for using electrostatic sensitive components.

Ethernet

Local network (bus structure) for text and data communication with a transfer rate of 10/100 Mbps.

Interface

- Physical interconnection (cable) of hardware elements such as PLCs, PCs, programming devices, printers or monitors.
- Interface for interactive software applications.

LAN

Local Area Network: LAN is a local network that consists of a group of computers and other devices that are distributed across a relatively restricted range and are linked with communication cables. The devices connected to a LAN are called nodes. The purpose of networks is the mutual use of files, printers or other resources.

Module

Modules are plug-in units for PLCs, programming devices or PCs. They are available as local modules, expansion modules, interfaces or mass storage (Mass storage module).

Motherboard

The motherboard is the core of the computer. Here, data are processed and stored, and interfaces and device I/Os are controlled and managed.

Operating system

Generic term which describes all functions for controlling and monitoring user program execution, distribution of system resources to the user programs and the operating mode in cooperation with the hardware (for example, Windows 7 Ultimate).

Poky

Cross-hardware framework of the "Yocto" project for creation of customized Embedded Linuxdistributions for industrial, embedded systems. The reference distribution "Poky" contains the OpenEmbedded build system "BitBake" and the OpenEmbedded kernel as well as a set of metadata.

Reset

Hardware reset: Reset/restart of the PC using a button/switch.

Yocto

Open Source collaboration under the guidance of the Linux Foundation for standardization of the Embedded Linux development. Yocto banks on the OpenEmbedded build system and propagates the "Poky" reference distribution.

Index

A

- Approval, (EAC)
- Arduino shield
 - Installing, 32
- Australia, 40

B

- Backup battery
 - Installing, 37

C

- CE marking, 39
- Certificates, 39
 - Approvals, 39
- Clearance, 22
- Components sensitive to electrostatic charge, 41
- Condensation, 20
- Configuration
 - SIMATIC IOT2020, 9
 - SIMATIC IOT2040, 10
- Connecting
 - Peripherals, 26
 - Power supply, 27
- Current consumption, 45

D

- DC power supply, 48
- Degree of protection, 45
- Dimension drawings, 44
- Directive
 - ESD Directive, 41

E

- EAC, 40
- ESD, 41
- ESD Directive, 41
- EU Declaration of Conformity, 39
- Expansion slot, 46

F

- FCC, 40
- Features, 7
- Flash, 46

G

- General technical specifications, 45

I

- Identification data, 21
- Installation on a DIN rail, 21
- Installing
 - Arduino shield, 32
 - Backup battery, 37
 - Mini PCIe card, 33
- Interfaces, 46
 - SIMATIC IOT2020, 9

L

- Labeling, 40
 - Korea, 40
- Limitation of liability, 14, 35

M

- Marking
 - EU Declaration of Conformity, 39
- Micro SD card, 31
- Mini PCIe card
 - Installing, 33
- Motherboard
 - Technical features, 50
- Mounting
 - Wall, 25
- Mounting position, 21
- Mounting type, 21

N

- New Zealand, 40
- Noise emission, 45

P

- Package contents, 19
 - Checking, 19
- Packaging, 19
 - Checking, 19
 - Removing, 19
- Ports
 - SIMATIC IOT2040, 10
- Power supply
 - Connecting, 27
 - DC power supply, 48
- Processor, 46
- PROFINET, 48
- Protective measure
 - Static electricity, 43

R

- Radiation, 15
 - High frequency radiation, 15
- RAM, 46
- Rating plate, 21
- Repairs, 35

S

- Safety instruction
 - Storage, 20
 - Transportation, 20
- Static electricity
 - Protective measures, 43
- Supply voltage, 45

U

- USB Flash Drive, 11

W

- Wall mounting, 21, 25
- Warranty, 13
- Weight, 45